

R (m)	ψ	R _{Cmax} (m)	10	15	20	25	30	35	40	45	50	55	60	←(m) ↓(kg)
60		26,2				12000	9250	6990	5520	4490	3710	3110	2600	
55		27,1				12000	10060	7770	6240	5140	4290	3600		
50		27,9				12000	10710	8450	6880	5720	4800			
45		28,9				12000	11340	9010	7360	6100				
40		29,7				12000	11850	9690	8100					
35		30,8					12000	10300						
30		30,0					12000							

R (m)	ψ/ψ	R _{Cmax} (m)	10	15	20	25	30	35	40	45	50	55	60	←(m) ↓(kg)
60														
55														
50		14,6	24000	23050	15290	11300	8860	7220	6030	5120	4400			
45		15,3		24000	16630	12400	9780	8000	6700	5700				
40		16,1		24000	18250	13850	11060	9130	7700					
35		16,9		24000	19540	14930	11970	9900						
30		17,3		24000	20260	15620	12600							

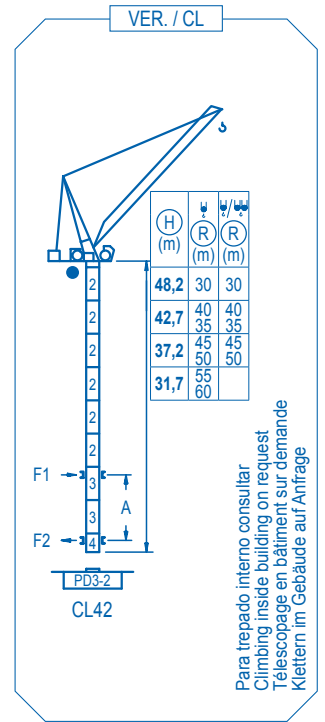
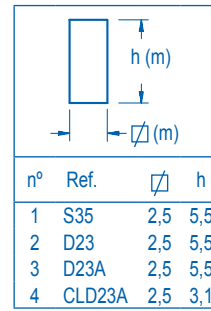
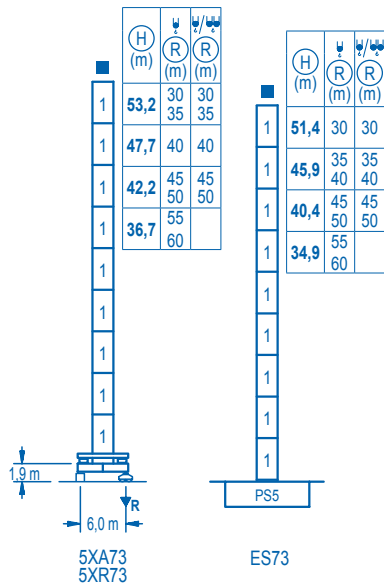

Para trepado interno consultar
Climbing inside building on request
Telescopage en bâtiment sur demande
Klettern im Gebäude auf Anfrage

R. máx.	En servicio In operation En service In Betrieb	5XR43..... 125 t	R. máx.	Fuera de servicio Out of service Hors service Ausser Betrieb	5XR43..... 155 t
----------------	---	------------------	----------------	---	------------------

Para otras zonas de viento o alturas superiores consultar
For other wind zones or additional hook heights on request
Pour d'autres zones de vent ou des hauteurs supplémentaires sur demande
Für andere Windzonen oder weiteren Hakenhöhen auf Anfrage

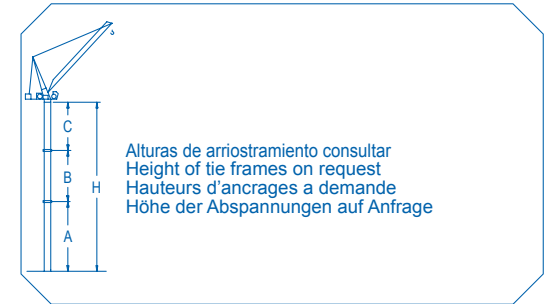

Alturas de arriostamiento consultar
Height of tie frames on request
Hauteurs d'ancrages a demande
Höhe der Abspannungen auf Anfrage

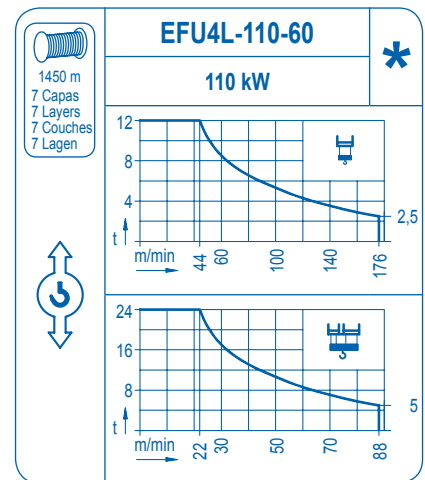
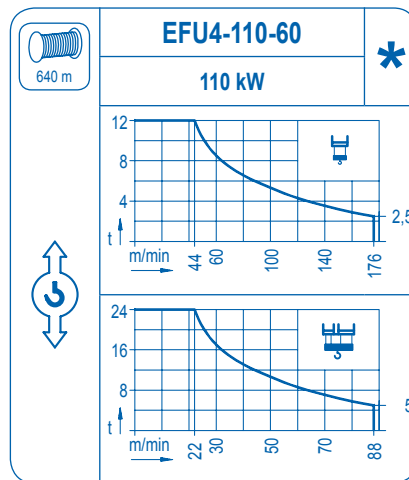
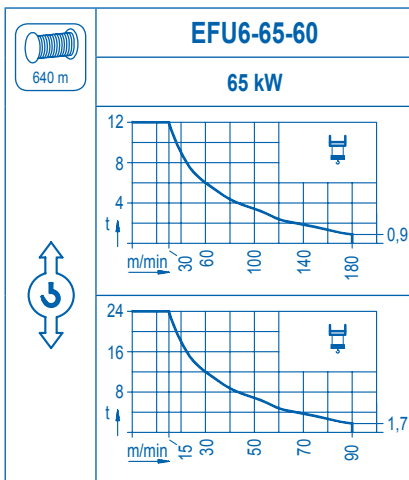
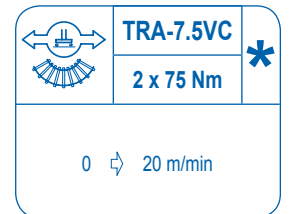
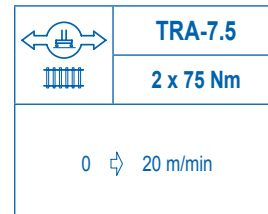
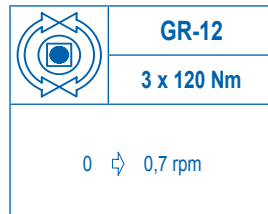
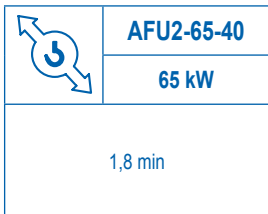

Tensión de alimentación Operating voltage Tension de service Betriebsspannung	400 V 3 ph 50 Hz
--	------------------------

Opcional Optional En option Kaufoption	*
---	---



Tel.: (34) 948 335 020
Fax: (34) 948 330 810
e-mail: info@comansa.com
www.comansa.com

Polígono Urbizkain
E-31620 HUARTE-PAMPLONA.- SPAIN

Construcciones Metálicas COMANSA S. A.

DS.1105.17 02/11 LCL 280 24 t