

| R | 8550 | 6750 | 5300 | 4050 | 3150 | 2300 | 1550 | |
|----|------|------|------|------|------|------|------|----|
| 30 | 8300 | 6500 | 5050 | 3800 | 2900 | | | m |
| 35 | | | | | | | | kg |
| 40 | | | | | | | | kg |
| 45 | | | | | | | | kg |
| 50 | | | | | | | | kg |
| 55 | | | | | | | | kg |
| 60 | | | | | | | | kg |

| R (m) | ψ | R _{Cmax} (m) | 10 | 15 | 20 | 25 | 30 | 35 | 40 | 45 | 50 | 55 | 60 | ←(m) ↓(kg) |
|-------|---|-----------------------|----|------|------|------|------|------|------|------|------|------|------|---------------|
| 60 | | 23,5 | | | 9000 | 7910 | 5550 | 4200 | 3310 | 2690 | 2220 | 1860 | 1550 | |
| 55 | | 24,8 | | 9000 | 8870 | 6430 | 4970 | 3990 | 3280 | 2740 | 2300 | | | |
| 50 | | 25,9 | | | 9000 | 7110 | 5580 | 4540 | 3760 | 3150 | | | | |
| 45 | | 27,2 | | | 9000 | 7710 | 6070 | 4920 | 4050 | | | | | |
| 40 | | 27,7 | | | 9000 | 8040 | 6460 | 5300 | | | | | | |
| 35 | | 28,8 | | | 9000 | 8490 | 6750 | | | | | | | |
| 30 | | 29,0 | | | 9000 | 8550 | | | | | | | | |

| R (m) | ψ/ψ | R _{Cmax} (m) | 10 | 15 | 20 | 25 | 30 | 35 | 40 | 45 | 50 | 55 | 60 | ←(m) ↓(kg) |
|-------|-----|-----------------------|-------|-------|-------|-------|------|------|------|------|------|----|----|---------------|
| 60 | | - | - | - | - | - | - | - | - | - | - | - | - | |
| 55 | | - | - | - | - | - | - | - | - | - | - | - | - | |
| 50 | | 12,3 | 18000 | 13720 | 9430 | 7100 | 5640 | 4640 | 3910 | 3350 | 2900 | | | |
| 45 | | 11,7 | 18000 | 13530 | 9750 | 7560 | 6130 | 5130 | 4380 | 3800 | | | | |
| 40 | | 13,5 | 18000 | 15890 | 11370 | 8780 | 7100 | 5930 | 5050 | | | | | |
| 35 | | 15,0 | | 18000 | 12720 | 9750 | 7840 | 6500 | | | | | | |
| 30 | | 16,5 | | 18000 | 14010 | 10530 | 8300 | | | | | | | |

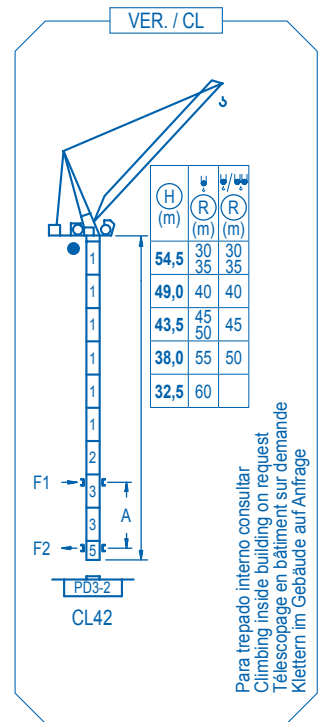
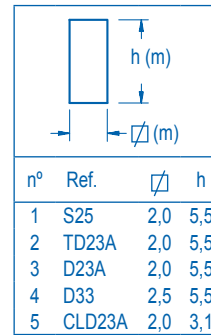
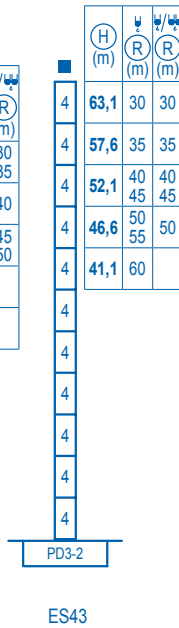
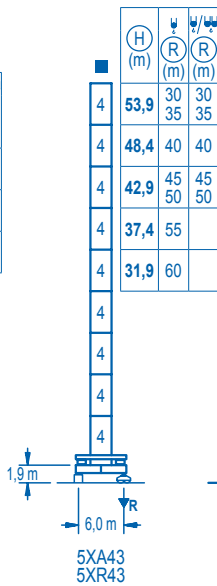
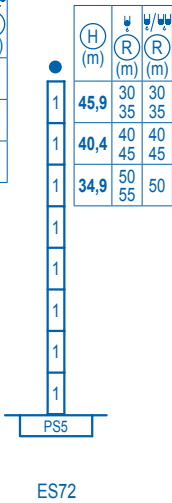
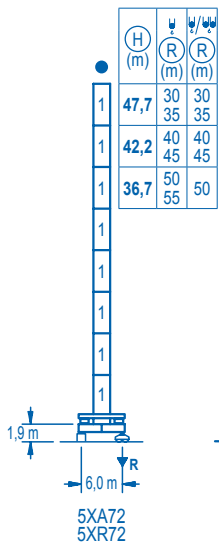

Para trepado interno consultar
Climbing inside building on request
Telescopage en bâtiment sur demande
Klettern im Gebäude auf Anfrage

| | | |
|----------------|---|------------------------------------|
| R. máx. | En servicio In operation En service In Betrieb | 5XR72.....111 t 5XR43.....119 t |
|----------------|---|------------------------------------|

| | | |
|----------------|---|------------------------------------|
| R. máx. | Fuera de servicio Out of service Hors service Ausser Betrieb | 5XR72.....144 t 5XR43.....167 t |
|----------------|---|------------------------------------|

Para otras zonas de viento o alturas superiores consultar
For other wind zones or additional hook heights on request
Pour d'autres zones de vent ou des hauteurs supplémentaires sur demande
Für andere Windzonen oder weiteren Hakenhöhen auf Anfrage

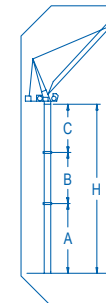

Alturas de arriostamiento consultar
Height of tie frames on request
Hauteurs d'ancrages a demande
Höhe der Abspannungen auf Anfrage

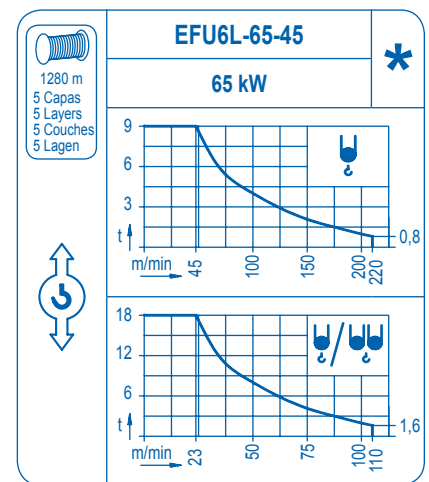
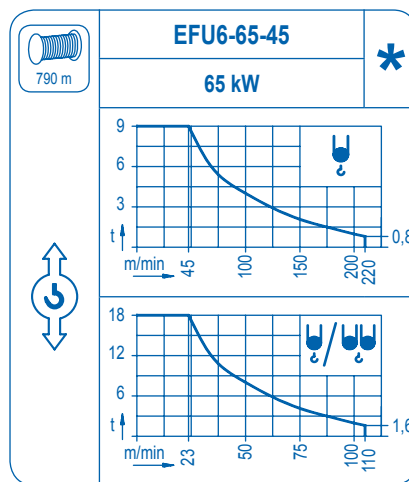
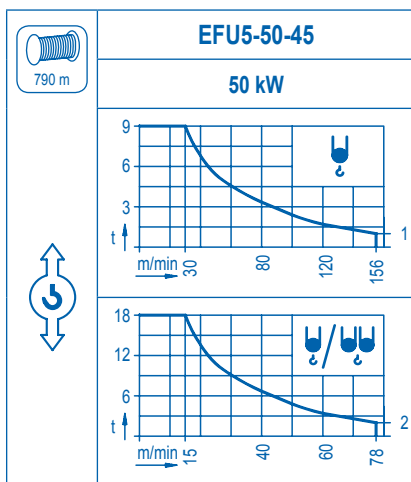
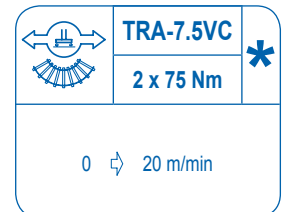
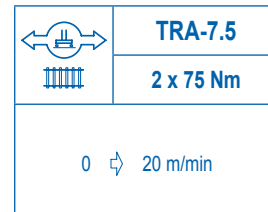
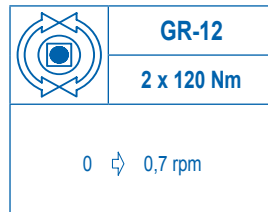
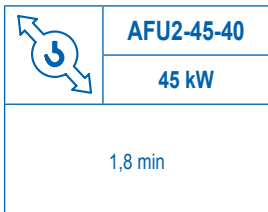

| | |
|--|------------------------|
| Tensión de alimentación Operating voltage Tension de service Betriebsspannung | 400 V 3 ph 50 Hz |
|--|------------------------|

| | |
|---|---|
| Opcional Optional En option Kaufoption | * |
|---|---|